

KA5x03xx-SERIES

KA5H0365R, KA5M0365R, KA5L0365R
KA5H0380R, KA5M0380R, KA5L0380R
Fairchild Power Switch(FPS)

Features

- Precision Fixed Operating Frequency (100/67/50kHz)
- Low Start-up Current(Typ. 100uA)
- Pulse by Pulse Current Limiting
- Over Current Protection
- Over Voltage Protection (Min. 25V)
- Internal Thermal Shutdown Function
- Under Voltage Lockout
- Internal High Voltage Sense FET
- Auto-Restart Mode

Applications

- SMPS for VCR, SVR, STB, DVD & DVCD
- SMPS for Printer, Facsimile & Scanner
- Adaptor for Camcorder

Description

The Fairchild Power Switch(FPS) product family is specially designed for an off-line SMPS with minimal external components. The Fairchild Power Switch(FPS) consists of a high voltage power SenseFET and a current mode PWM IC. Included PWM controller integrates the fixed frequency oscillator, the under voltage lock-out, the leading edge blanking, the optimized gate turn-on/turn-off driver, the thermal shutdown protection, the over voltage protection, and the temperature compensated precision current sources for the loop compensation and the fault protection circuitry. Compared to a discrete MOSFET and a PWM controller or an RCC solution, a Fairchild Power Switch(FPS) can reduce the total component count, design size and weight and at the same time increase efficiency, productivity, and system reliability. It has a basic platform well suited for the cost effective design in either a flyback converter or a forward converter

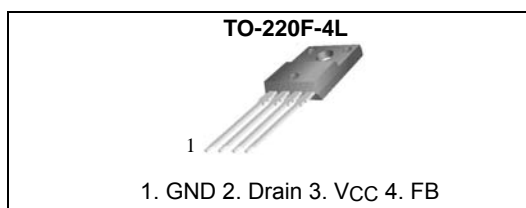

Internal Block Diagram

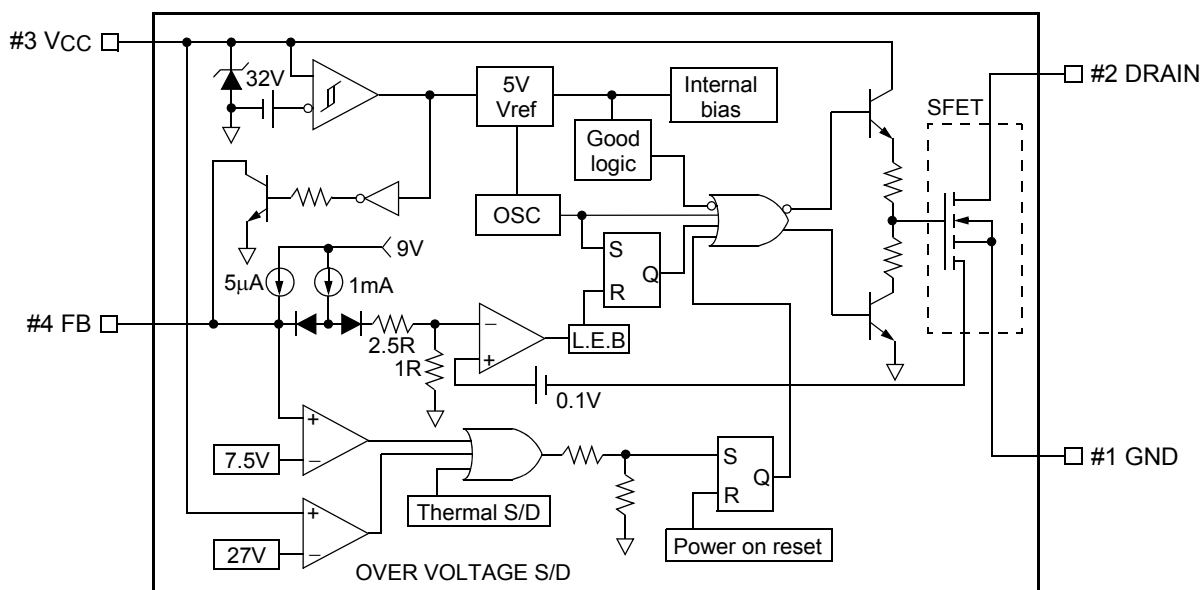

Rev.1.0.7

Absolute Maximum Ratings

(Ta=25°C, unless otherwise specified)

| Characteristic | Symbol | Value | Unit |
|--|---------------------|-------------------------|------|
| KA5H0365R, KA5M0365R, KA5L0365R | | | |
| Drain-Gate Voltage (R _{GS} =1MΩ) | V _{DGR} | 650 | V |
| Gate-Source (GND) Voltage | V _{GS} | ±30 | V |
| Drain Current Pulsed ⁽¹⁾ | I _{DM} | 12.0 | ADC |
| Continuous Drain Current (T _C =25°C) | I _D | 3.0 | ADC |
| Continuous Drain Current (T _C =100°C) | I _D | 2.4 | ADC |
| Single Pulsed Avalanche Energy ⁽²⁾ | E _{AS} | 358 | mJ |
| Maximum Supply Voltage | V _{CC,MAX} | 30 | V |
| Analog Input Voltage Range | V _{FB} | -0.3 to V _{SD} | V |
| Total Power Dissipation | PD | 75 | W |
| | Derating | 0.6 | W/°C |
| Operating Junction Temperature. | T _J | +150 | °C |
| Operating Ambient Temperature. | T _A | -40 to +85 | °C |
| Storage Temperature Range. | T _{STG} | -55 to +150 | °C |
| KA5H0380R, KA5M0380R, KA5L0380R | | | |
| Drain-Gate Voltage (R _{GS} =1MΩ) | V _{DGR} | 800 | V |
| Gate-Source (GND) Voltage | V _{GS} | ±30 | V |
| Drain Current Pulsed ⁽¹⁾ | I _{DM} | 12.0 | ADC |
| Continuous Drain Current (T _C =25°C) | I _D | 3.0 | ADC |
| Continuous Drain Current (T _C =100°C) | I _D | 2.1 | ADC |
| Single Pulsed Avalanche Energy ⁽²⁾ | E _{AS} | 95 | mJ |
| Maximum Supply Voltage | V _{CC,MAX} | 30 | V |
| Analog Input Voltage Range | V _{FB} | -0.3 to V _{SD} | V |
| Total Power Dissipation | PD | 75 | W |
| | Derating | 0.6 | W/°C |
| Operating Junction Temperature. | T _J | +150 | °C |
| Operating Ambient Temperature. | T _A | -40 to +85 | °C |
| Storage Temperature Range. | T _{STG} | -55 to +150 | °C |

Note:

1. Repetitive rating: Pulse width limited by maximum junction temperature
2. L = 51mH, starting T_J = 25°C
3. L = 13μH, starting T_J = 25°C

Electrical Characteristics (SenseFET Part)

(Ta = 25°C unless otherwise specified)

| Parameter | Symbol | Condition | Min. | Typ. | Max. | Unit |
|---|---------|--|------|------|------|------|
| KA5H0365R, KA5M0365R, KA5L0365R | | | | | | |
| Drain-Source Breakdown Voltage | BVDSS | VGS=0V, ID=50μA | 650 | - | - | V |
| Zero Gate Voltage Drain Current | IDSS | VDS=Max. Rating, VGS=0V | - | - | 50 | μA |
| | | VDS=0.8Max. Rating, VGS=0V, TC=125°C | - | - | 200 | μA |
| Static Drain-Source on Resistance ^(Note) | RDS(ON) | VGS=10V, ID=0.5A | - | 3.6 | 4.5 | Ω |
| Forward Transconductance ^(Note) | gfs | VDS=50V, ID=0.5A | 2.0 | - | - | S |
| Input Capacitance | Ciss | VGS=0V, VDS=25V, f=1MHz | - | 720 | - | pF |
| Output Capacitance | Coss | | - | 40 | - | |
| Reverse Transfer Capacitance | Crss | | - | 40 | - | |
| Turn On Delay Time | td(on) | VDD=0.5BVDSS, ID=1.0A (MOSFET switching time is essentially independent of operating temperature) | - | 150 | - | nS |
| Rise Time | tr | | - | 100 | - | |
| Turn Off Delay Time | td(off) | | - | 150 | - | |
| Fall Time | tf | | - | 42 | - | |
| Total Gate Charge (Gate-Source+Gate-Drain) | Qg | VGS=10V, ID=1.0A, VDS=0.5BVDSS (MOSFET switching time is essentially independent of operating temperature) | - | - | 34 | nC |
| Gate-Source Charge | Qgs | | - | 7.3 | - | |
| Gate-Drain (Miller) Charge | Qgd | | - | 13.3 | - | |
| KA5H0380R, KA5M0380R, KA5L0380R | | | | | | |
| Drain-Source Breakdown Voltage | BVDSS | VGS=0V, ID=50μA | 800 | - | - | V |
| Zero Gate Voltage Drain Current | IDSS | VDS=Max. Rating, VGS=0V | - | - | 250 | μA |
| | | VDS=0.8Max. Rating, VGS=0V, TC=125°C | - | - | 1000 | μA |
| Static Drain-Source on Resistance ^(Note) | RDS(ON) | VGS=10V, ID=0.5A | - | 4.0 | 5.0 | Ω |
| Forward Transconductance ^(Note) | gfs | VDS=50V, ID=0.5A | 1.5 | 2.5 | - | S |
| Input Capacitance | Ciss | VGS=0V, VDS=25V, f=1MHz | - | 779 | - | pF |
| Output Capacitance | Coss | | - | 75.6 | - | |
| Reverse Transfer Capacitance | Crss | | - | 24.9 | - | |
| Turn On Delay Time | td(on) | VDD=0.5BVDSS, ID=1.0A (MOSFET switching time is essentially independent of operating temperature) | - | 40 | - | nS |
| Rise Time | tr | | - | 95 | - | |
| Turn Off Delay Time | td(off) | | - | 150 | - | |
| Fall Time | tf | | - | 60 | - | |
| Total Gate Charge (Gate-Source+Gate-Drain) | Qg | VGS=10V, ID=1.0A, VDS=0.5BVDSS (MOSFET switching time is essentially independent of operating temperature) | - | - | 34 | nC |
| Gate-Source Charge | Qgs | | - | 7.2 | - | |
| Gate-Drain (Miller) Charge | Qgd | | - | 12.1 | - | |

Note:

1. Pulse test: Pulse width ≤ 300μS, duty ≤ 2%

$$2. S = \frac{1}{R}$$

Electrical Characteristics (Control Part) (Continued)

(Ta = 25°C unless otherwise specified)

| Characteristic | Symbol | Test condition | Min. | Typ. | Max. | Unit |
|--|--------------------|--|------|------|------|-------|
| UVLO SECTION | | | | | | |
| Start Threshold Voltage | VSTART | VFB=GND | 14 | 15 | 16 | V |
| Stop Threshold Voltage | VSTOP | VFB=GND | 8.4 | 9 | 9.6 | V |
| OSCILLATOR SECTION | | | | | | |
| Initial Accuracy | FOSC | KA5H0365R KA5H0380R | 90 | 100 | 110 | kHz |
| Initial Accuracy | FOSC | KA5M0365R KA5M0380R | 61 | 67 | 73 | kHz |
| Initial Accuracy | FOSC | KA5L0365R KA5L0380R | 45 | 50 | 55 | kHz |
| Frequency Change With Temperature ⁽²⁾ | - | -25°C≤Ta≤+85°C | - | ±5 | ±10 | % |
| Maximum Duty Cycle | Dmax | KA5H0365R KA5H0380R | 62 | 67 | 72 | % |
| Maximum Duty Cycle | Dmax | KA5M0365R KA5M0380R KA5L0365R KA5L0380R | 72 | 77 | 82 | % |
| FEEDBACK SECTION | | | | | | |
| Feedback Source Current | IFB | Ta=25°C, 0V≤Vfb≤3V | 0.7 | 0.9 | 1.1 | mA |
| Shutdown Feedback Voltage | VSD | Vfb≥6.5V | 6.9 | 7.5 | 8.1 | V |
| Shutdown Delay Current | Idelay | Ta=25°C, 5V≤Vfb≤VSD | 4 | 5 | 6 | μA |
| REFERENCE SECTION | | | | | | |
| Output Voltage ⁽¹⁾ | Vref | Ta=25°C | 4.80 | 5.00 | 5.20 | V |
| Temperature Stability ⁽¹⁾⁽²⁾ | Vref/ΔT | -25°C≤Ta≤+85°C | - | 0.3 | 0.6 | mV/°C |
| CURRENT LIMIT(SELF-PROTECTION)SECTION | | | | | | |
| Peak Current Limit | I _{OVER} | Max. inductor current | 1.89 | 2.15 | 2.41 | A |
| PROTECTION SECTION | | | | | | |
| Over Voltage Protection | VOVP | VCC≥24V | 25 | 27 | 29 | V |
| Thermal Shutdown Temperature (Tj) ⁽¹⁾ | TSD | - | 140 | 160 | - | °C |
| TOTAL STANDBY CURRENT SECTION | | | | | | |
| Start-up Current | I _{START} | VCC=14V | - | 100 | 170 | μA |
| Operating Supply Current (Control Part Only) | I _{OP} | VCC≤28 | - | 7 | 12 | mA |

Note:

1. These parameters, although guaranteed, are not 100% tested in production
2. These parameters, although guaranteed, are tested in EDS(water test) process

Typical Performance Characteristics(SenseFET part) (KA5H0365R, KA5M0365R, KA5L0365R)

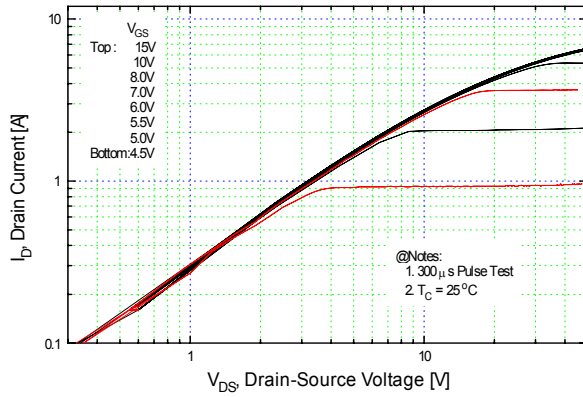

Figure 1. Output Characteristics

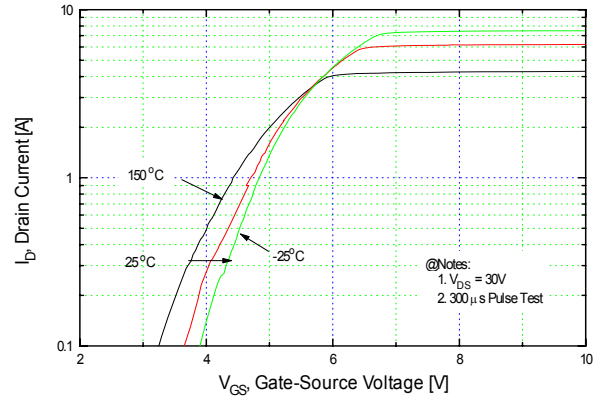

Figure 2. Transfer Characteristics

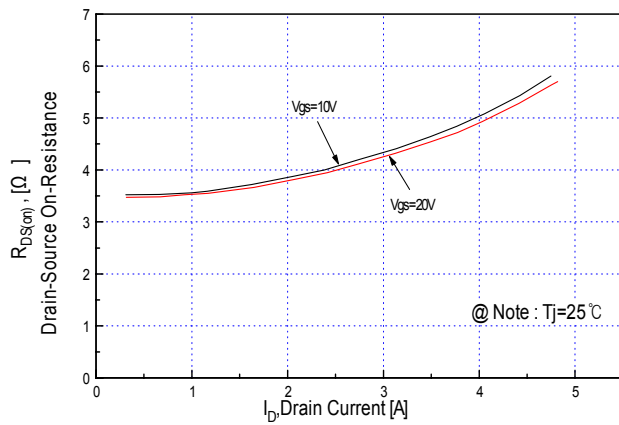

Figure 3. On-Resistance vs. Drain Current

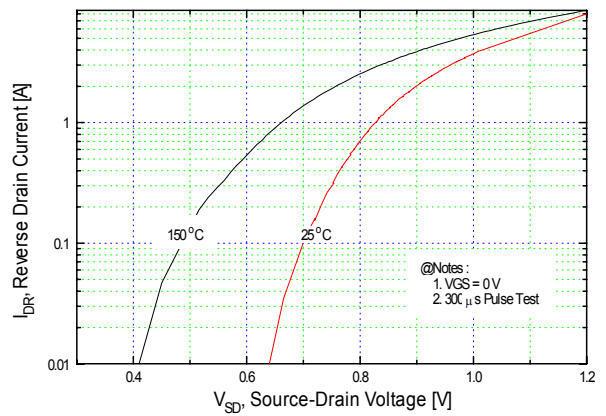

Figure 4. Source-Drain Diode Forward Voltage

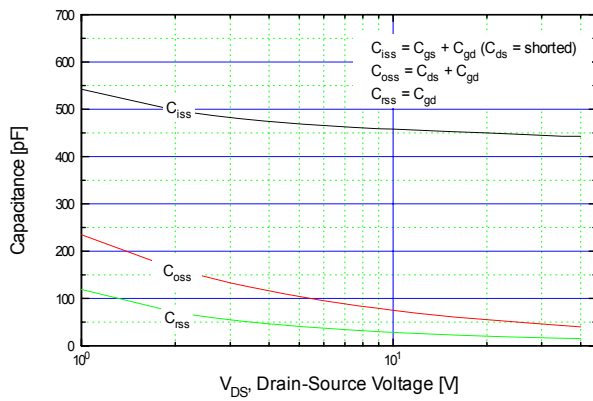

Figure 5. Capacitance vs. Drain-Source Voltage

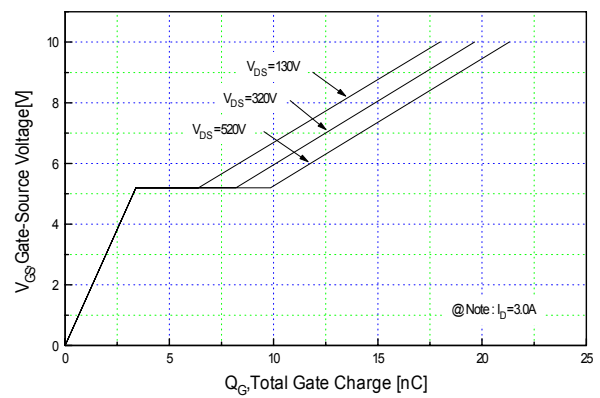

Figure 6. Gate Charge vs. Gate-Source Voltage

Typical Performance Characteristics (Continued)

(KA5H0365R, KA5M0365R, KA5L0365R)

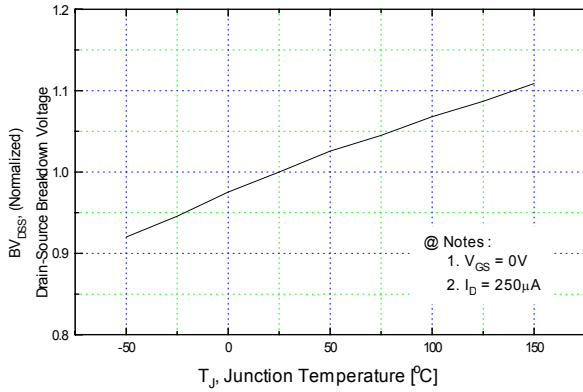

Figure 7. Breakdown Voltage vs. Temperature

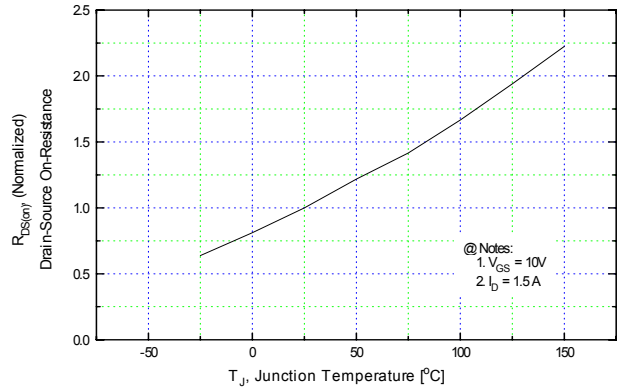

Figure 8. On-Resistance vs. Temperature

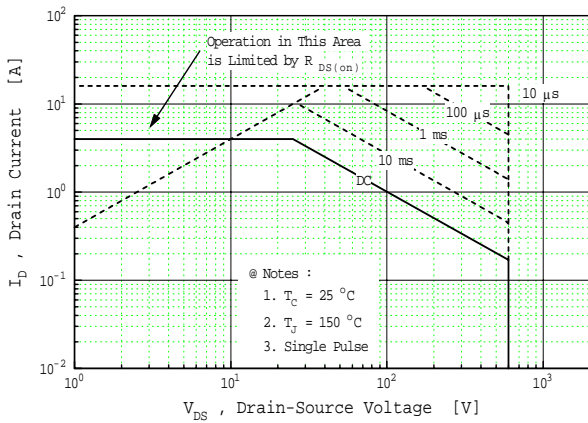

Figure 9. Max. Safe Operating Area

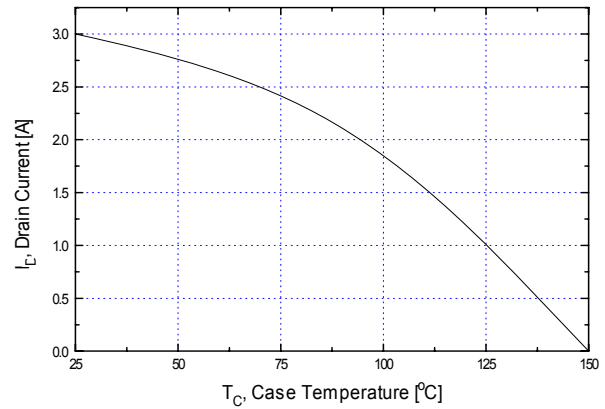

Figure 10. Max. Drain Current vs. Case Temperature

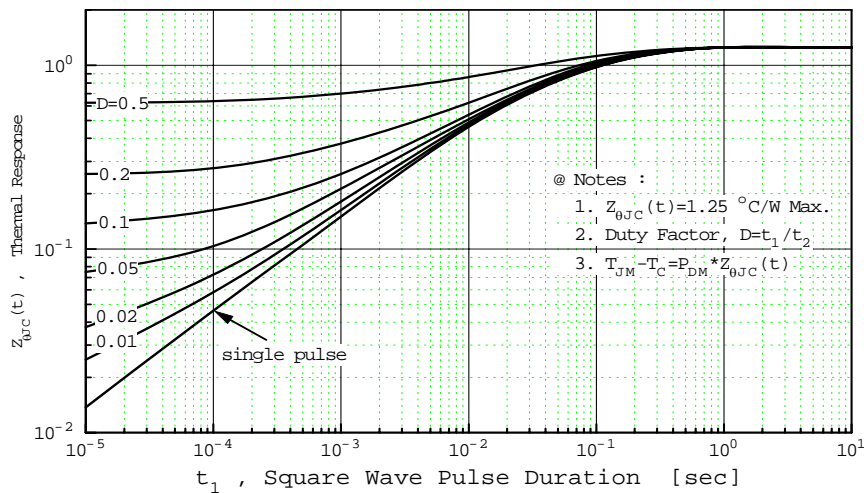

Figure 11. Thermal Response

Typical Performance Characteristics (Continued)

(KA5H0380R, KA5M0380R, KA5L0380R)

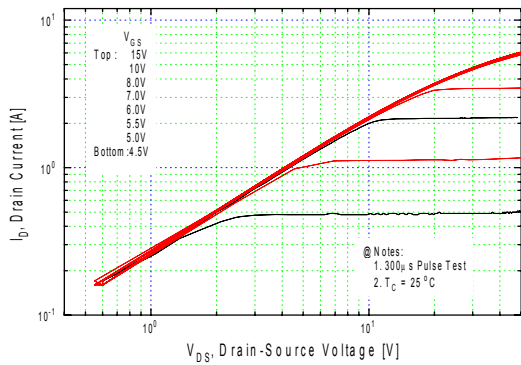

Figure 1. Output Characteristics

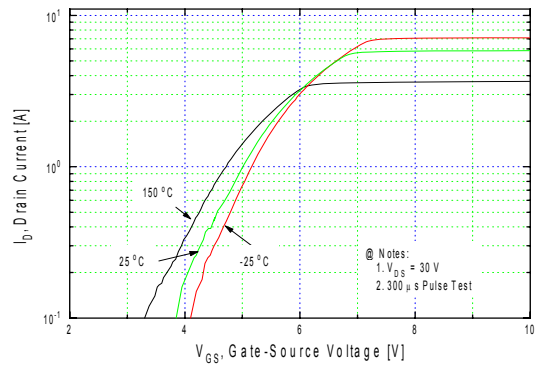

Figure 2. Transfer Characteristics

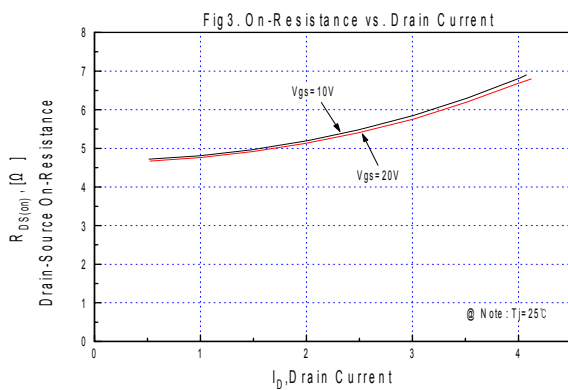

Figure 3. On-Resistance vs. Drain Current

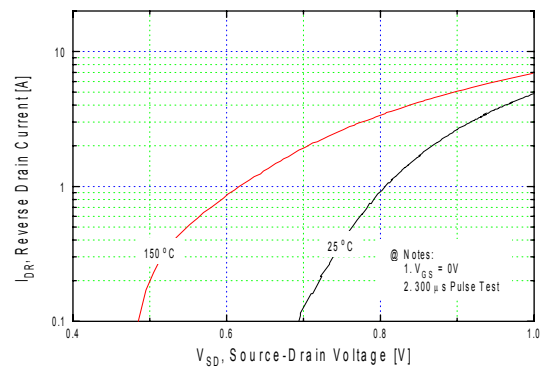

Figure 4. Source-Drain Diode Forward Voltage

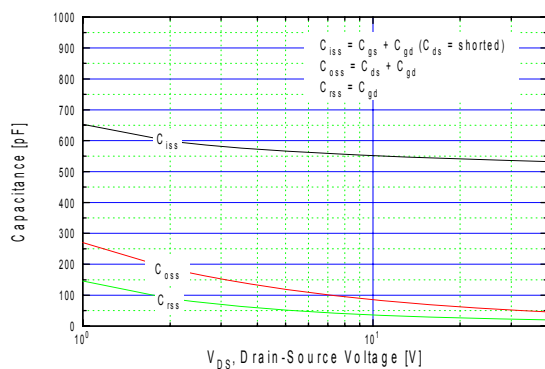

Figure 5. Capacitance vs. Drain-Source Voltage

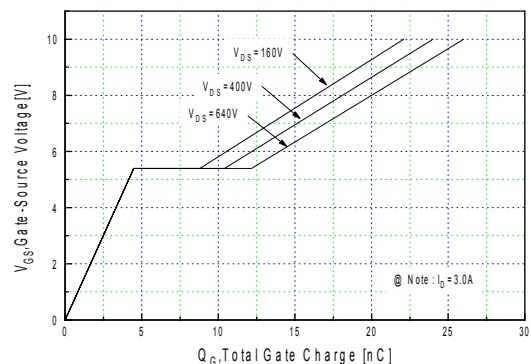

Figure 6. Gate Charge vs. Gate-Source Voltage

Typical Performance Characteristics (Continued)

(KA5H0380R, KA5M0380R, KA5L0380R)

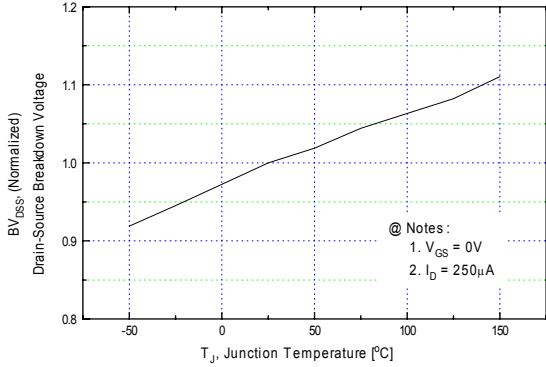

Figure 7. Breakdown Voltage vs. Temperature

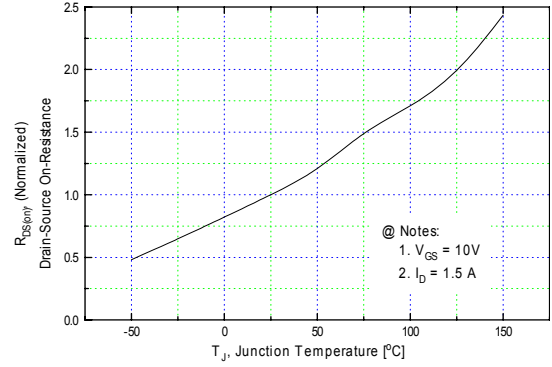

Figure 8. On-Resistance vs. Temperature

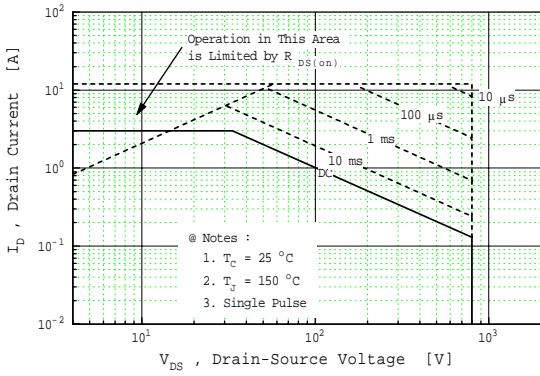

Figure 9. Max. Safe Operating Area

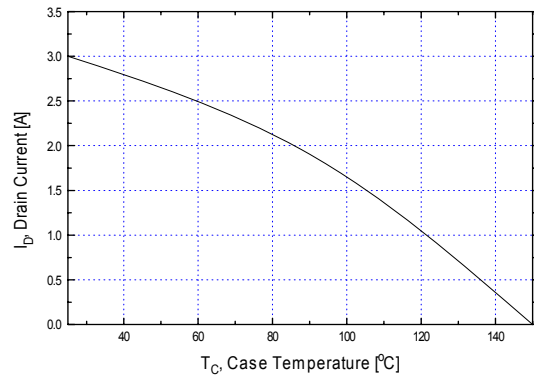

Figure 10. Max. Drain Current vs. Case Temperature

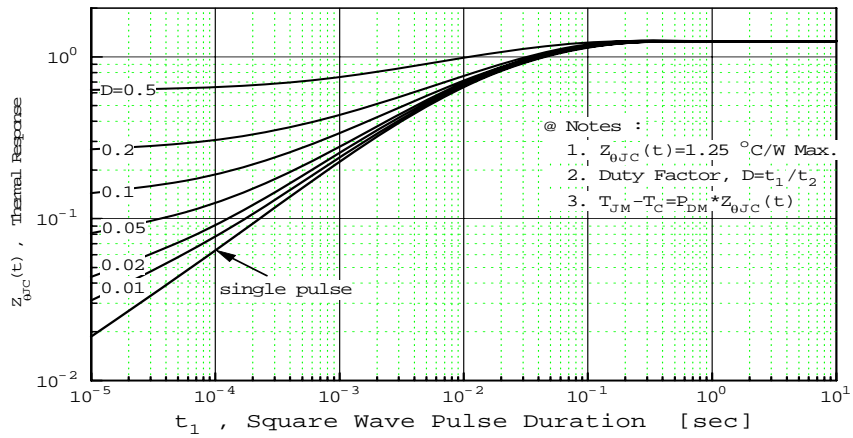

Figure 11. Thermal Response

Typical Performance Characteristics (Control Part) (Continued)

(These characteristic graphs are normalized at $T_a = 25^\circ\text{C}$)

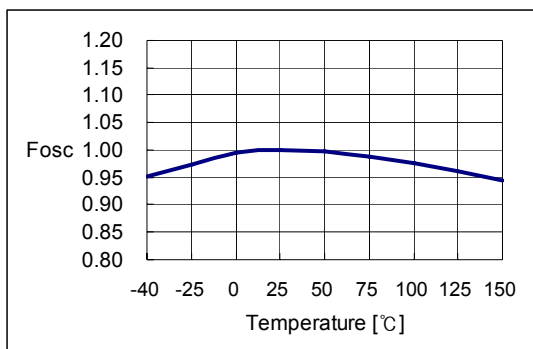

Figure 1. Operating Frequency

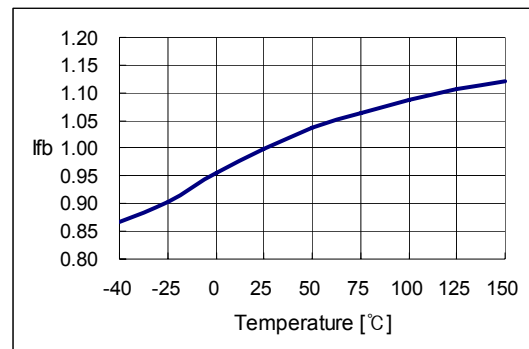

Figure 2. Feedback Source Current

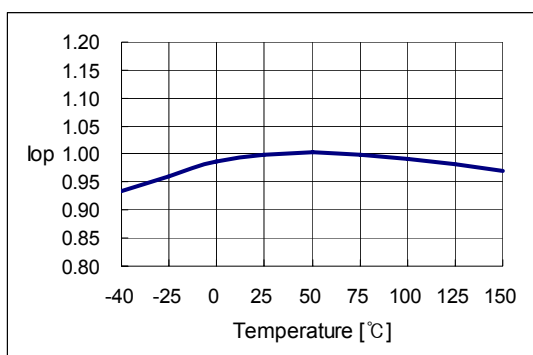

Figure 3. Operating Supply Current

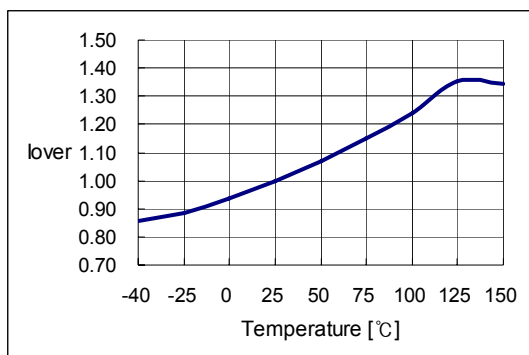

Figure 4. Peak Current Limit

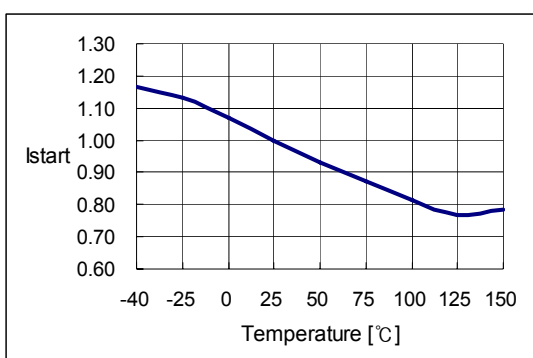

Figure 5. Start up Current

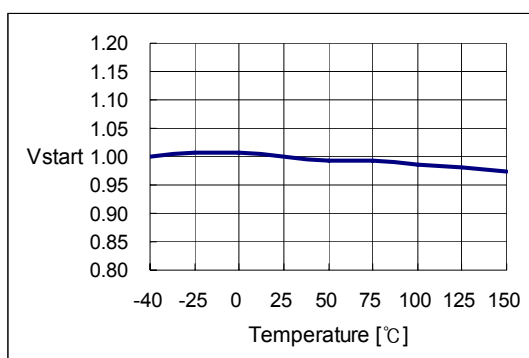

Figure 6. Start Threshold Voltage

Typical Performance Characteristics (Continued)

(These characteristic graphs are normalized at $T_a = 25^\circ\text{C}$)

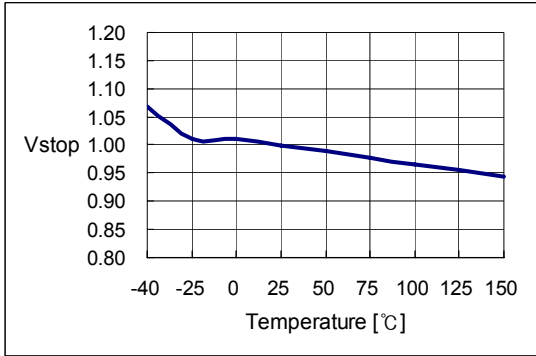

Figure 7. Stop Threshold Voltage

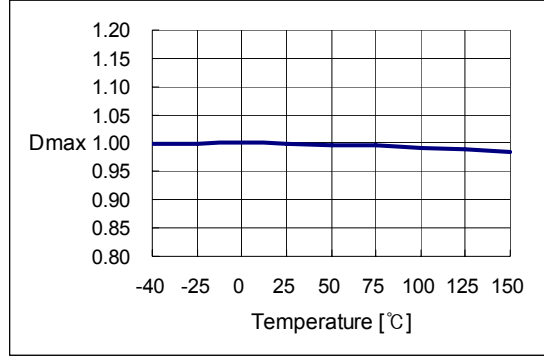

Figure 8. Maximum Duty Cycle

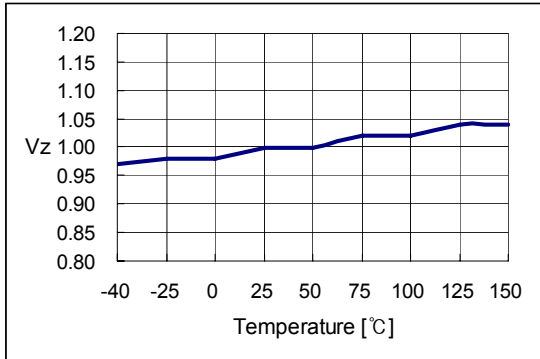

Figure 9. VCC Zener Voltage

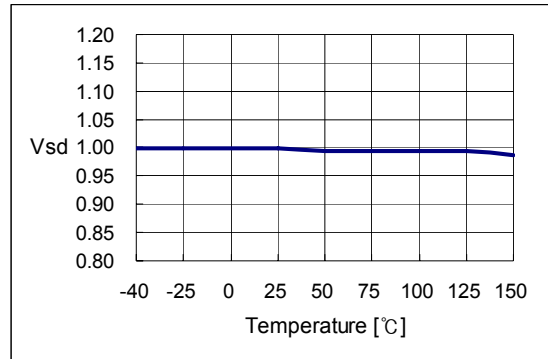

Figure 10. Shutdown Feedback Voltage

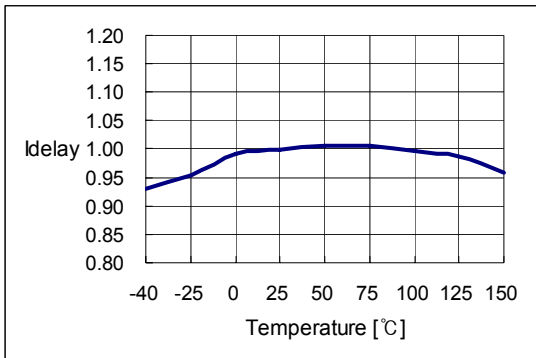

Figure 11. Shutdown Delay Current

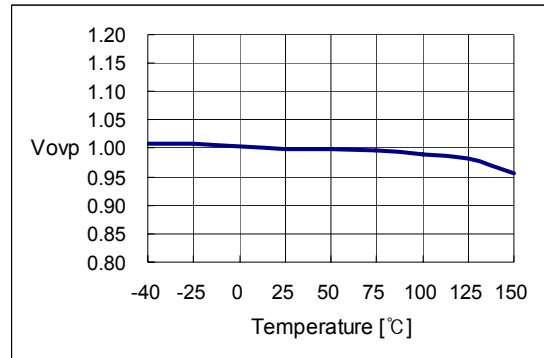

Figure 12. Over Voltage Protection

Typical Performance Characteristics (Continued)

(These characteristic graphs are normalized at Ta = 25°C)

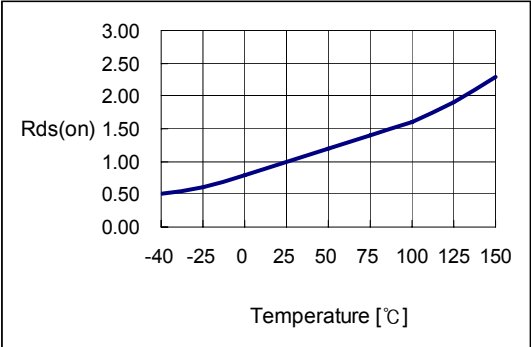
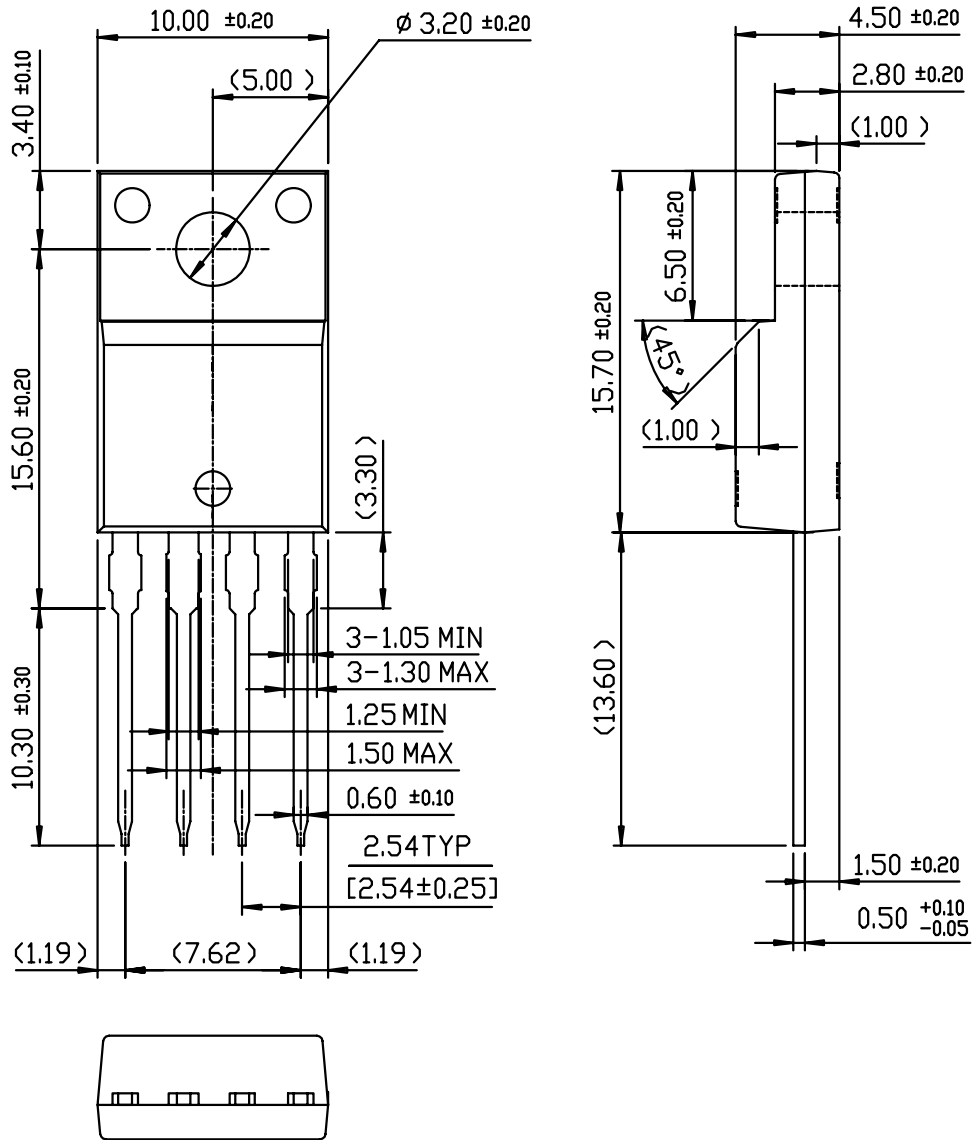

Figure13. Static Drain-Source on Resistance

Package Dimensions

TO-220F-4L



Package Dimensions (Continued)

TO-220F-4L(Forming)

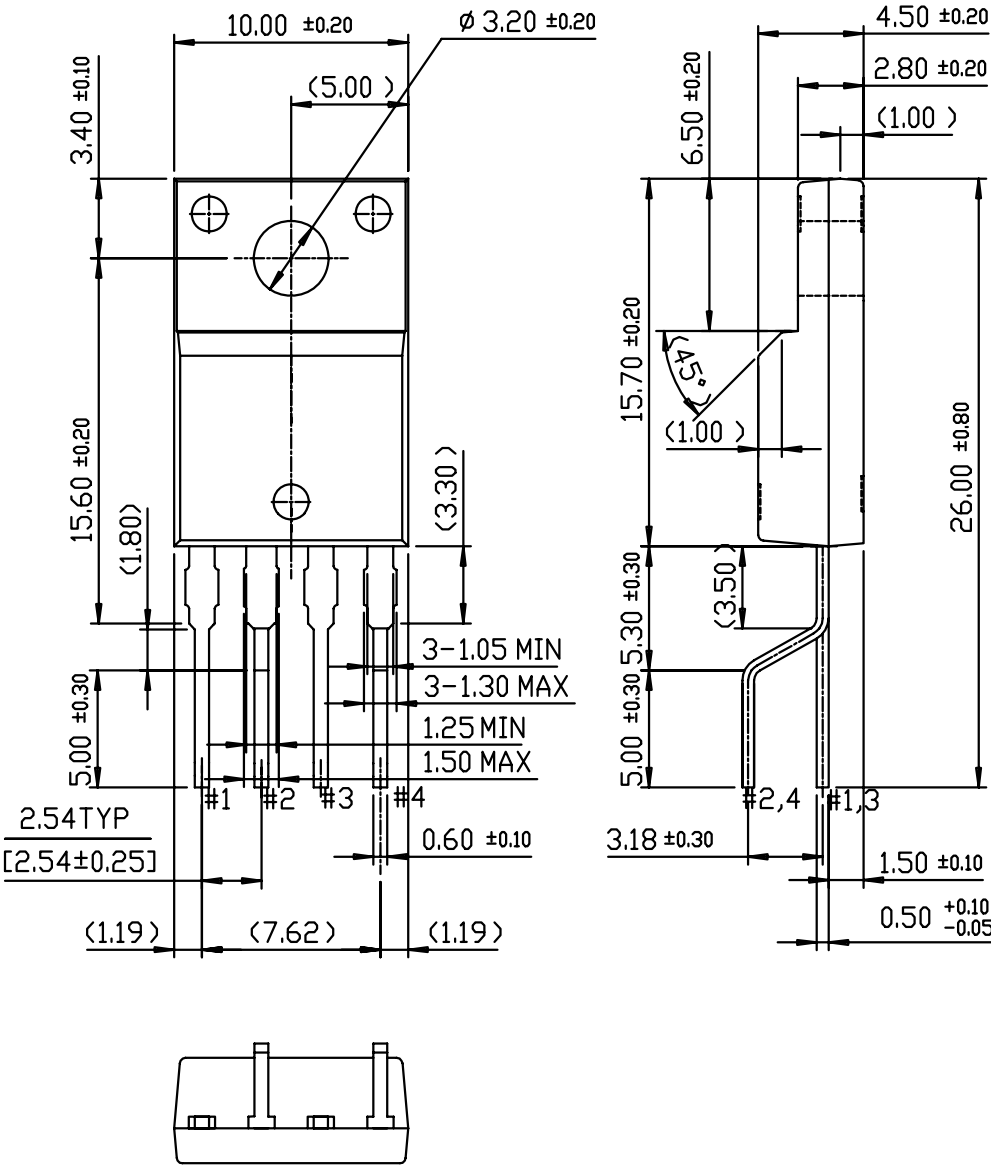

Ordering Information

| Product Number | Package | Marking Code | BVDSS | FOSC | RDS(on) |
|----------------|---------------------|--------------|-------|--------|---------|
| KA5H0365RTU | TO-220F-4L | 5H0365R | 650V | 100kHz | 3.6Ω |
| KA5H0365RYDTU | TO-220F-4L(Forming) | | | | |
| KA5M0365RTU | TO-220F-4L | 5M0365R | 650V | 67kHz | 3.6Ω |
| KA5M0365RYDTU | TO-220F-4L(Forming) | | | | |
| KA5L0365RTU | TO-220F-4L | 5L0365R | 650V | 50kHz | 3.6Ω |
| KA5L0365RYDTU | TO-220F-4L(Forming) | | | | |
| Product Number | Package | Marking Code | BVDSS | FOSC | RDS(on) |
| KA5H0380RTU | TO-220F-4L | 5H0380R | 800V | 100kHz | 4.6Ω |
| KA5H0380RYDTU | TO-220F-4L(Forming) | | | | |
| KA5M0380RTU | TO-220F-4L | 5M0380R | 800V | 67kHz | 4.6Ω |
| KA5M0380RYDTU | TO-220F-4L(Forming) | | | | |
| KA5L0380RTU | TO-220F-4L | 5L0380R | 800V | 50kHz | 4.6Ω |
| KA5L0380RYDTU | TO-220F-4L(Forming) | | | | |





TU :Non Forming Type

YDTU : Forming type



TRADEMARKS

The following includes registered and unregistered trademarks and service marks, owned by Fairchild Semiconductor and/or its global subsidiaries, and is not intended to be an exhaustive list of all such trademarks.

- | | | | |
|---|--|--|---|
| 2Cool™ | FPS™ | PDP SPM™ | The Power Franchise® |
| AccuPower™ | F-PFS™ | Power-SPM™ | the power™ |
| Auto-SPM™ | FRFET® | PowerTrench® | franchise |
| AX-CAP™* | Global Power Resource™ | PowerXS™ | TinyBoost™ |
| BitSiC® | Green FPS™ | Programmable Active Droop™ | TinyBuck™ |
| Build it Now™ | Green FPS™ e-Series™ | QFET® | TinyCalc™ |
| CorePLUS™ | Gmax™ | QS™ | TinyLogic® |
| CorePOWER™ | GTO™ | Quiet Series™ | TINYOPTO™ |
| CROSSVOL™ | IntelliMAX™ | RapidConfigure™ | TinyPower™ |
| CTL™ | ISOPLANAR™ |  ™ | TinyPWM™ |
| Current Transfer Logic™ | Making Small Speakers Sound Louder and Better™ | Saving our world, 1mW/W/kW at a time™ | TinyWire™ |
| DEUXPEED® | MegaBuck™ | SignalWise™ | TranSiC® |
| Dual Cool™ | MICROCOUPLER™ | SmartMax™ | TriFault Detect™ |
| EcoSPARK® | MicroFET™ | SMART START™ | TRUECURRENT®* |
| EfficientMax™ | MicroPak™ | SPM® | µSerDes™ |
| ESBC™ | MicroPak2™ | STEALTH™ |  ™ |
|  ™ | MillerDrive™ | SuperFET® | UHC® |
| Fairchild® | MotionMax™ | SuperSOT™-3 | Ultra FRFET™ |
| Fairchild Semiconductor® | Motion-SPM™ | SuperSOT™-6 | UniFET™ |
| FACT Quiet Series™ | mWSaver™ | SupreMOS® | VCX™ |
| FACT® | OptoHiT™ | SyncFET™ | VisualMax™ |
| FAST® | OPTOLOGIC® | Sync-Lock™ | VoltagePlus™ |
| FastvCore™ | OPTOPLANAR® |  SYSTEM GENERAL®* | XS™ |
| FETBench™ | | | |
| FlashWriter®* | | | |

* Trademarks of System General Corporation, used under license by Fairchild Semiconductor.

DISCLAIMER

FAIRCHILD SEMICONDUCTOR RESERVES THE RIGHT TO MAKE CHANGES WITHOUT FURTHER NOTICE TO ANY PRODUCTS HEREIN TO IMPROVE RELIABILITY, FUNCTION, OR DESIGN. FAIRCHILD DOES NOT ASSUME ANY LIABILITY ARISING OUT OF THE APPLICATION OR USE OF ANY PRODUCT OR CIRCUIT DESCRIBED HEREIN; NEITHER DOES IT CONVEY ANY LICENSE UNDER ITS PATENT RIGHTS, NOR THE RIGHTS OF OTHERS. THESE SPECIFICATIONS DO NOT EXPAND THE TERMS OF FAIRCHILD'S WORLDWIDE TERMS AND CONDITIONS, SPECIFICALLY THE WARRANTY THEREIN, WHICH COVERS THESE PRODUCTS.

LIFE SUPPORT POLICY

FAIRCHILD'S PRODUCTS ARE NOT AUTHORIZED FOR USE AS CRITICAL COMPONENTS IN LIFE SUPPORT DEVICES OR SYSTEMS WITHOUT THE EXPRESS WRITTEN APPROVAL OF FAIRCHILD SEMICONDUCTOR CORPORATION.

As used herein:

- Life support devices or systems are devices or systems which, (a) are intended for surgical implant into the body or (b) support or sustain life, and (c) whose failure to perform when properly used in accordance with instructions for use provided in the labeling, can be reasonably expected to result in a significant injury of the user.
- A critical component in any component of a life support, device, or system whose failure to perform can be reasonably expected to cause the failure of the life support device or system, or to affect its safety or effectiveness.

ANTI-COUNTERFEITING POLICY

Fairchild Semiconductor Corporation's Anti-Counterfeiting Policy. Fairchild's Anti-Counterfeiting Policy is also stated on our external website, www.fairchildsemi.com, under Sales Support.

Counterfeiting of semiconductor parts is a growing problem in the industry. All manufacturers of semiconductor products are experiencing counterfeiting of their parts. Customers who inadvertently purchase counterfeit parts experience many problems such as loss of brand reputation, substandard performance, failed applications, and increased cost of production and manufacturing delays. Fairchild is taking strong measures to protect ourselves and our customers from the proliferation of counterfeit parts. Fairchild strongly encourages customers to purchase Fairchild parts either directly from Fairchild or from Authorized Fairchild Distributors who are listed by country on our web page cited above. Products customers buy either from Fairchild directly or from Authorized Fairchild Distributors are genuine parts, have full traceability, meet Fairchild's quality standards for handling and storage and provide access to Fairchild's full range of up-to-date technical and product information. Fairchild and our Authorized Distributors will stand behind all warranties and will appropriately address any warranty issues that may arise. Fairchild will not provide any warranty coverage or other assistance for parts bought from Unauthorized Sources. Fairchild is committed to combat this global problem and encourage our customers to do their part in stopping this practice by buying direct or from authorized distributors.

PRODUCT STATUS DEFINITIONS

Definition of Terms

| Datasheet Identification | Product Status | Definition |
|--------------------------|-----------------------|---|
| Advance Information | Formative / In Design | Datasheet contains the design specifications for product development. Specifications may change in any manner without notice. |
| Preliminary | First Production | Datasheet contains preliminary data; supplementary data will be published at a later date. Fairchild Semiconductor reserves the right to make changes at any time without notice to improve design. |
| No Identification Needed | Full Production | Datasheet contains final specifications. Fairchild Semiconductor reserves the right to make changes at any time without notice to improve the design. |
| Obsolete | Not In Production | Datasheet contains specifications on a product that is discontinued by Fairchild Semiconductor. The datasheet is for reference information only. |